

# CP4-60086030-02

## 56 to 64 GHz PIN Diode SP4T Switch, Reflective

### Description

Model CP4-60086030-02 is a V-band, single pole four throw, reflective PIN diode switch fabricated in GaAs monolithic technology and incorporating a TTL compatible driver. Its primary function is to switch signals in the frequency range of 56 to 64 GHz from one waveguide channel to others. The switch is activated by a TTL signal applied to the control connector.

The SP4T switch is in a compact 1.7" x 1.4" x 1.02" gold-plated package, and its excellent isolation, low insertion loss and fast switching features make it a perfect switch of choice for RF engineers.

### Features

- Low insertion loss/high isolation
- Nanosecond class fast switching
- Complete solid state solution
- WR-15 waveguide interface

### Applications

- Test instrumentation
- Telecommunication
- WiGig application development
- Wireless 5G technology

### Performance Chart

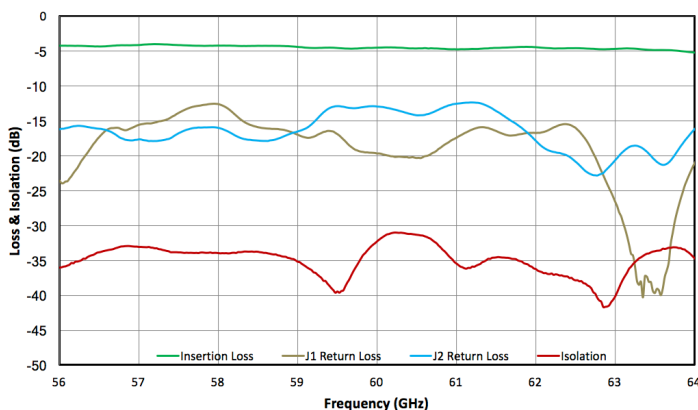

### Specifications

Frequency:	56 to 64 GHz
Insertion loss:	5.0 dB typical, 6.0 dB maximum
Isolation:	30 dB minimum
I/O VSWR:	2.0 : 1 typical
Control:	TTL
DC bias:	+/- 5 V@20 mA typical
I/O connectors:	WR-15 waveguide w/UG-385/U-M flanges
Outline:	H1515-901-3
Switching speed:	200 nS maximum
RF power handling:	+23 dBm CW
Temperature range:	-55 to +85 °C

## Outline

Dimensions are in inches

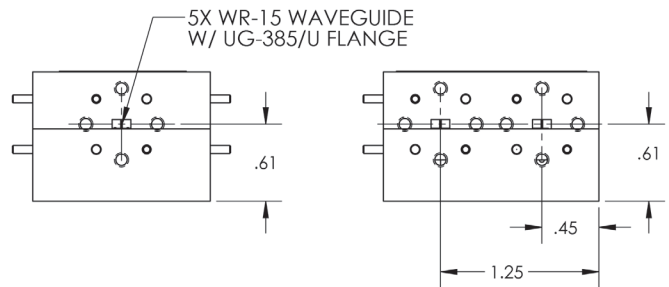
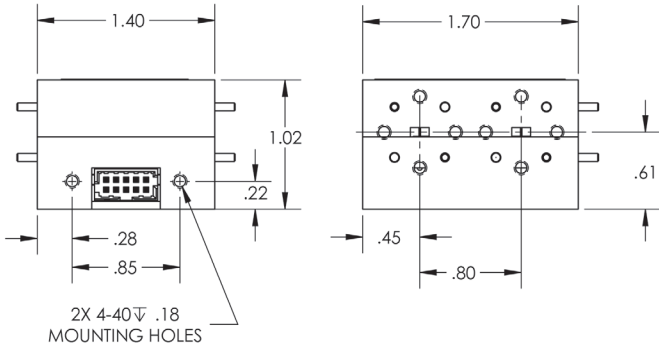
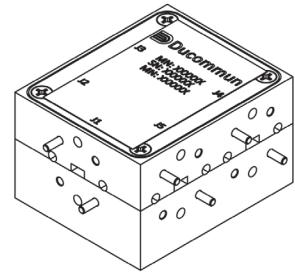
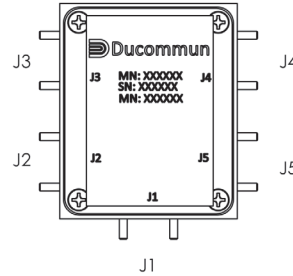
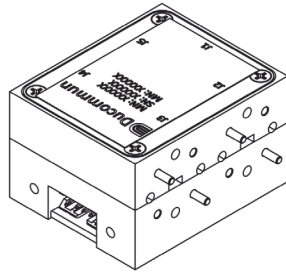

## Control Logic and Connector PIN#

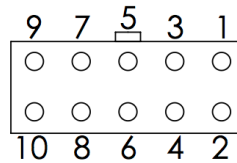
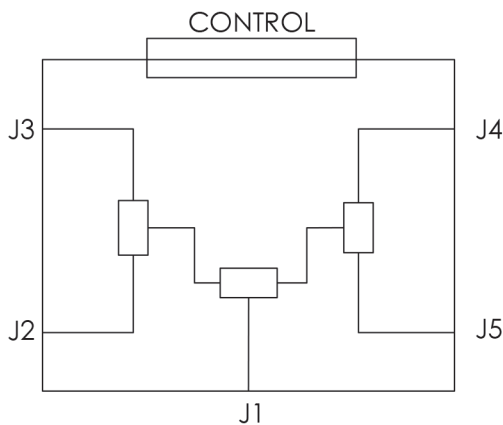

CONTROL CONNECTOR  
AS VIEWED FROM SWITCH FACE

MATING CONNECTOR:  
MOLEX 51110-1051  
CRIMP TERMINAL:  
MOLEX 50394-8100  
CRIMP TOOL:  
MOLEX 11-01-0204

LOGIC TABLE		
C0	C1	PATH ON
1	0	J1-J2
0	0	J1-J3
1	1	J1-J4
0	1	J1-J5

PIN#	FUNCTION
1	GND
2	+5V
3	C1
4	GND
5	GND
6	GND
7	C0
8	GND
9	GND
10	-5V